



Cutting | Bending | Welding | Automation



TPS

✦ Bevel Tube Laser Cutting Machine ✦

Company Culture

MISSION

Intelligent manufacturing changes future

VALUES

Customer-focused and employee-based

VISION

Become a respectable enterprise in the global metal forming equipment field

Company Profile



13

Global Branches



100+

Countries Covered



4

Manufacturing Bases



30+

Global Service Outlets

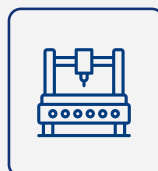

8,000+

Delivery Capability



96,000m²

Occupied Area



TPS 3000-6000W

Bevel Tube Laser Cutting Machine

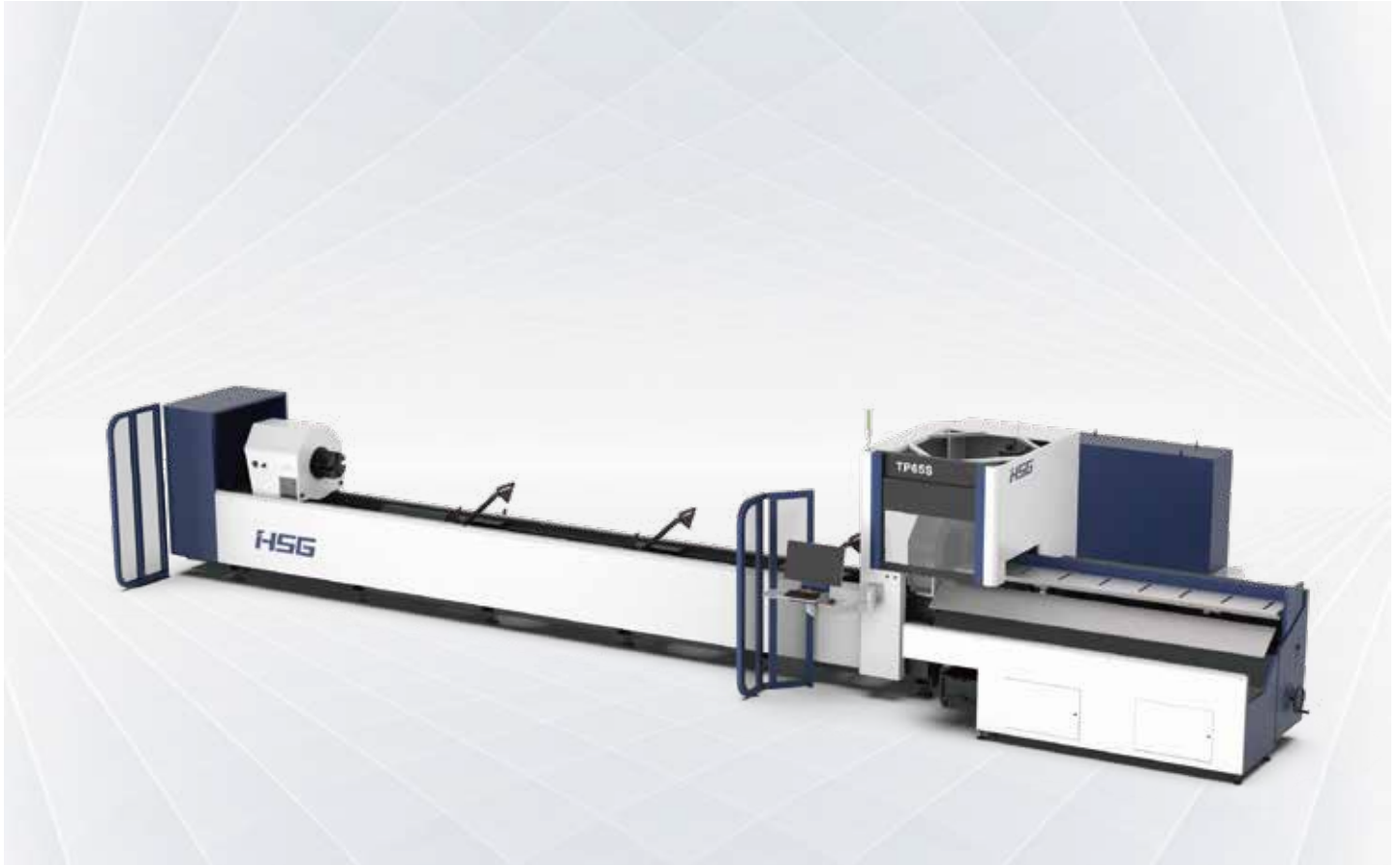

Technical Parameters

Technical Parameter	TP65S
Power	3000-6000W
Rotating Speed of Chucks	120r/min
No-load Speed	140m/min
Acceleration	1.2G
X/Y-axis Positioning Accuracy	±0.03mm/m
X/Y-axis Repositioning Accuracy	±0.03mm
*Tailing Length	≥220mm
Cutting Capacity	Round tubeΦ20 - Φ273mm Square tube□20*20 - □200*200 Rectangular diagonal≤273mm
Weight of Single Tube	200kg
Overall Dimensions(L*W*H) with Loading Racks	12500×4700×2600mm
Optional	8m machine bed
Safety Certification	ETL, THX

*Only in the case of straight cutting can it be achieved

* Machine appearance, technical parameters, function description, data comparison shown in this page are from HSG in-house laboratory.
All testing results and experimental data shall be subject to real machine.

High Speed and Intelligent for Better Processing

- High Speed and Precise
High-speed data transmission without time delay and strong positional energy control.
- High rotational Speed and Air Velocity
Bus system and servo motor reduce unproductive time.

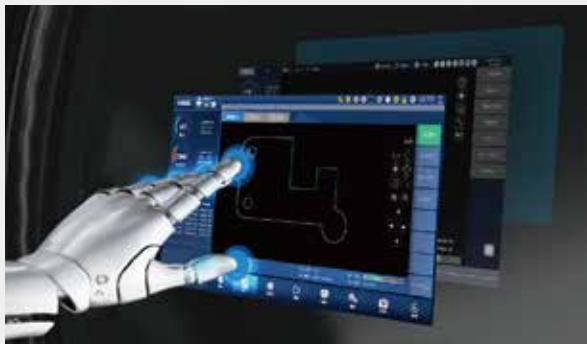

X9000 Bus-based Tube Cutting Control System

- Simple Interface
Clear interface is convenient for users operating and shows cutting data in real time to save time and costs.
- Functional Integration Control
A number of core functions are showed centrally on the interface to reduce operating steps and users can easily learn to operate.

Intelligent Digital Chucks

- Closed-loop control and wireless data transmission in real time.
- Know claws clamping status and accurate tube size .
- Self-adaptive adjustment of clamping force.
- Stop immediately if empty or wrong tube is clamped, so as to lower work error rate.





Powerful Functions Make You Never Spend Time Worrying

- Component Real-time Monitoring and Maintenance Alert
All components are detected in real time to ensure the stable use and the system is equipped with maintenance alert for careful component management



LA4 Bevel Cutting Head

- 0-45° bevel takes its shape once, for the convenience of subsequent welding and decrease of reprocessing costs.

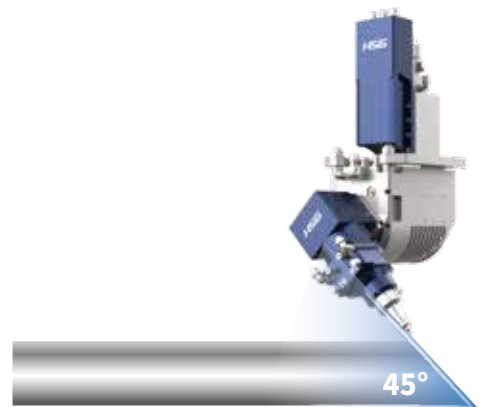

Tube Splicing Technology

- The operating control offers 50+ kinds of tube splicing patterns, for convenience of subsequent welding, such as splicing of male and female head of square tube, 90° arc splicing, splicing of round tube tee, splicing of cut-through holes, 45° splicing of hexagon, splicing of angle iron and channel steel, etc.



Machine Foundation *The marked size has about 10mm error

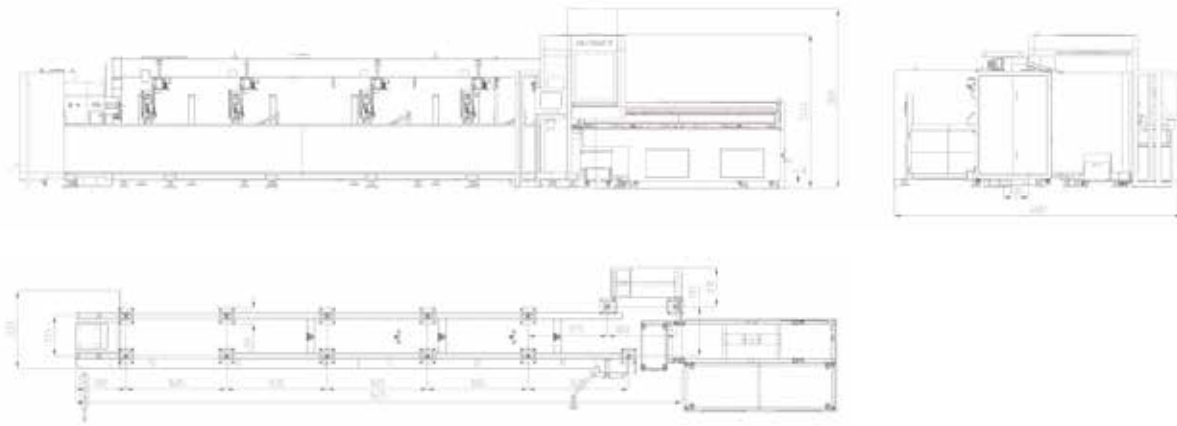

Cutting Samples

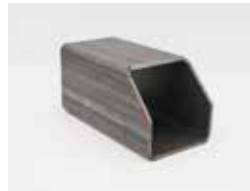

Cutting Capacity

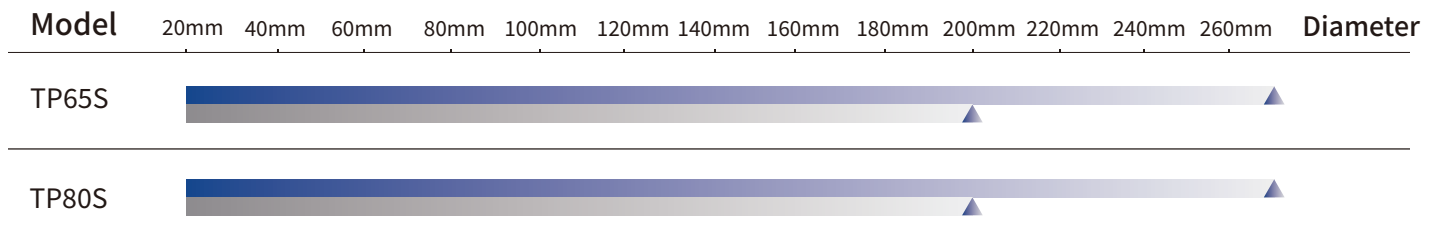

square tube
 round tube

The actual machines shall prevail and above data & pictures are only for reference.



Intelligent Manufacturing Changes Future



As a global enterprise, HSG sticks to providing professional and convenient service support to customers at home and board



Professional Training

Multiple technical training service and free operation training for customers and dealers in time



Efficient Support

Humanistic service model, online services and 7*24 hotline to offer solutions and assistance



Optimized Transport

Multi-channel transport solutions and professional transport solution team will provide various transport cases for to satisfy the demand of customers and save transports fees



Sufficient Accessories

Highly efficient accessories delivery service, multiple network inventory jointly responds to accessories demand to shorten customer's waiting times and accelerate production



Careful Services

Domestic door-to-door service and free proofing, global 100+dealers provide efficient and convenient services



Intelligent Manufacturing Changes Future



Website



Facebook



Youtube

Headquarters Add.: No. 4, Anye Road, Shunjiang Community Industrial Park,
Beijiao Town, Shunde District, Foshan, Guangdong, China
Website: www.hsglaser.com
Email: info@hsglaser.com
Tel: +86 757-66833906